

PNP SILICON POWER TRANSISTOR

2SB772

PNP SILICON POWER TRANSISTOR

DESCRIPTION

The 2SB772 is PNP silicon transistor suited for the output stage of 3 W audio amplifier, voltage regulator, DC-DC converter and relay driver.

FEATURES

- Low saturation voltage
 $V_{CE(sat)} \leq -0.5 \text{ V}$ ($I_C = -2 \text{ A}$, $I_B = -0.2 \text{ A}$)
- Excellent h_{FE} linearity and high h_{FE}
 $h_{FE} = 60$ to 400 ($V_{CE} = -2 \text{ V}$, $I_C = -1 \text{ A}$)
- Less cramping space required due to small and thin package and reducing the trouble for attachment to a radiator.
No insulator bushing required.

ABSOLUTE MAXIMUM RATINGS

Maximum Temperature	
Storage Temperature	-55 to +150°C
Junction Temperature	150°C Maximum
Maximum Power Dissipation	
Total Power Dissipation ($T_A = 25^\circ\text{C}$)	1.0 W
Total Power Dissipation ($T_C = 25^\circ\text{C}$)	10 W
Maximum Voltages and Currents ($T_A = 25^\circ\text{C}$)	
V_{CBO} Collector to Base Voltage	-40 V
V_{CEO} Collector to Emitter Voltage	-30 V
V_{EBO} Emitter to Base Voltage	-5.0 V
$I_{C(DC)}$ Collector Current (DC)	-3.0 A
$I_{C(pulse)}$ ^{Note} Collector Current (pulse)	-7.0 A

Note Pulse Test $PW \leq 350 \mu\text{s}$, Duty Cycle $\leq 2\%$

★ PACKAGE DRAWING (Unit: mm)

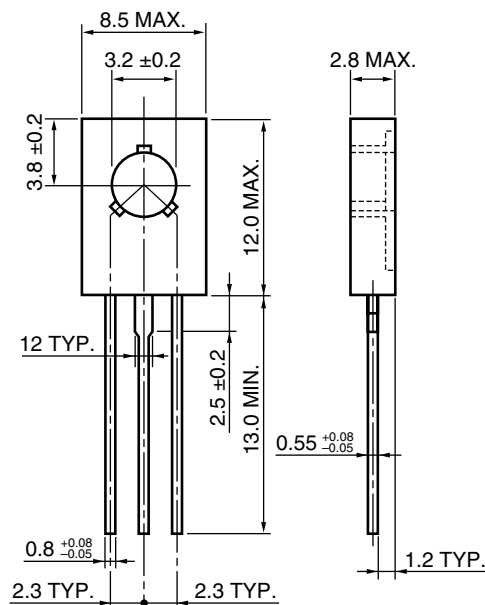

- 1: Emitter
- 2: Collector: connected to mounting plane
- 3: Base

ELECTRICAL CHARACTERISTICS ($T_A = 25^\circ\text{C}$)

CHARACTERISTIC	SYMBOL	TEST CONDITIONS	MIN.	TYP.	MAX.	UNIT
DC Current Gain	h_{FE1}	$V_{CE} = -2.0 \text{ V}$, $I_C = -20 \text{ mA}$ ^{Note}	30	220		
DC Current Gain	h_{FE2}	$V_{CE} = -2.0 \text{ V}$, $I_C = -1.0 \text{ mA}$ ^{Note}	60	160	400	
Gain Bandwidth Product	f_T	$V_{CE} = -5.0 \text{ V}$, $I_C = -0.1 \text{ A}$		80		MHz
Output Capacitance	C_{ob}	$V_{CB} = -10 \text{ V}$, $I_E = 0$, $f = 1.0 \text{ MHz}$		55		pF
Collector Cutoff Current	I_{CBO}	$V_{CB} = -30 \text{ V}$, $I_E = 0 \text{ A}$			-1.0	μA
Emitter Cutoff Current	I_{EBO}	$V_{EB} = -3.0 \text{ V}$, $I_C = 0 \text{ A}$			-1.0	μA
Collector Saturation Voltage	$V_{CE(sat)}$	$I_C = -2.0 \text{ A}$, $I_B = -0.2 \text{ A}$ ^{Note}		-0.3	-0.5	V
Base Saturation Voltage	$V_{BE(sat)}$	$I_C = -2.0 \text{ A}$, $I_B = -0.2 \text{ A}$ ^{Note}		-1.0	-2.0	V

Note Pulse Test: $PW \leq 350 \mu\text{s}$, Duty Cycle $\leq 2\%$

CLASSIFICATION OF h_{FE}

Rank	R	Q	P	E
Range	60 to 120	100 to 200	160 to 320	200 to 400

Remark Test Conditions: $V_{CE} = -2.0 \text{ V}$, $I_C = 1.0 \text{ A}$

The information in this document is subject to change without notice. Before using this document, please confirm that this is the latest version.

Not all products and/or types are available in every country. Please check with an NEC Electronics sales representative for availability and additional information.

TYPICAL CHARACTERISTICS (TA = 25°C, unless otherwise noted.)

TOTAL POWER DISSIPATION vs. AMBIENT TEMPERATURE

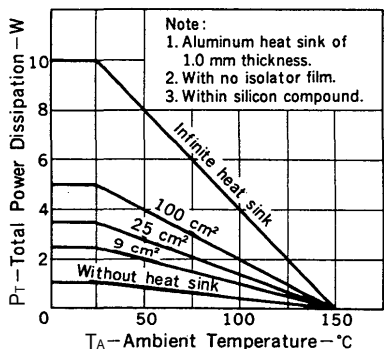

DERATING CURVES FOR ALL TYPES

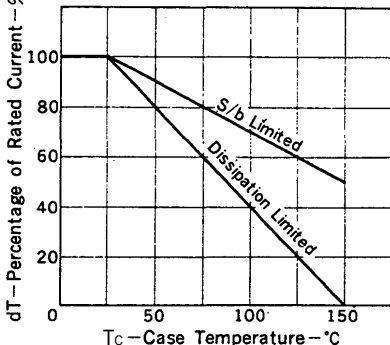

THERMAL RESISTANCE vs. PULSE WIDTH

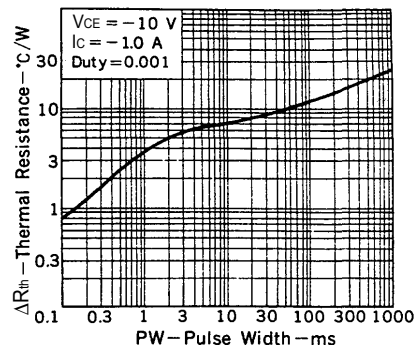

SAFE OPERATING AREAS

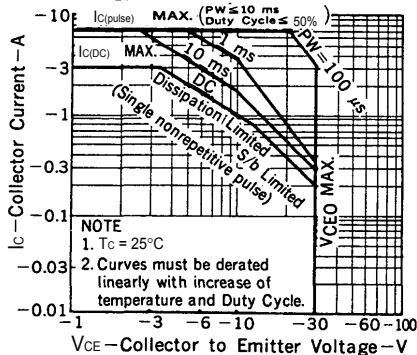

COLLECTOR CURRENT vs. COLLECTOR TO EMITTER VOLTAGE

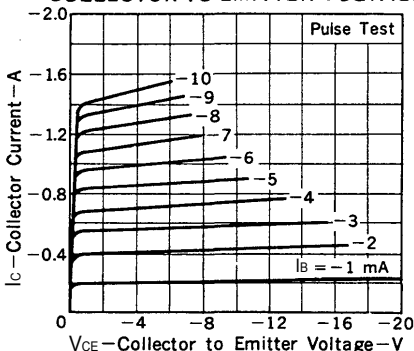

DC CURRENT GAIN, BASE TO EMITTER VOLTAGE vs. COLLECTOR CURRENT

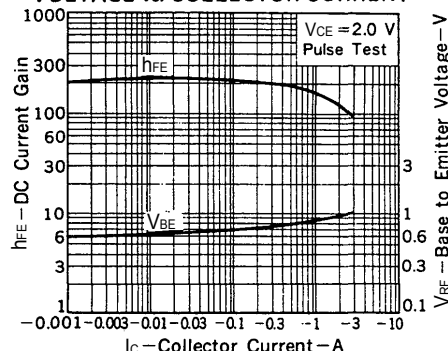

BASE AND COLLECTOR SATURATION VOLTAGE vs. COLLECTOR CURRENT

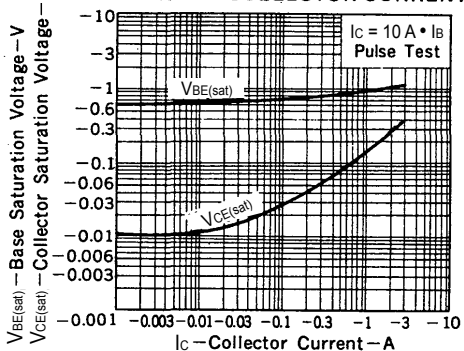

GAIN BANDWIDTH PRODUCT vs. COLLECTOR CURRENT

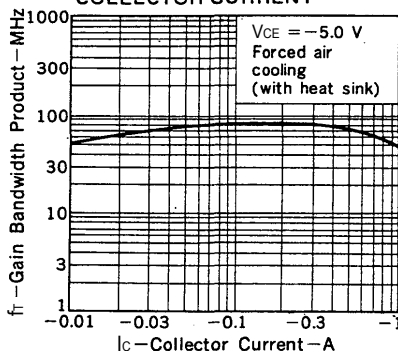

INPUT AND OUTPUT CAPACITANCE vs. REVERSE VOLTAGE

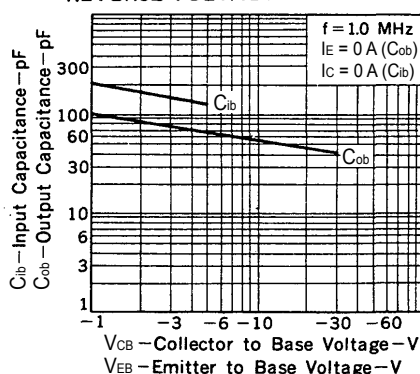

• **The information in this document is current as of March, 2004. The information is subject to change without notice. For actual design-in, refer to the latest publications of NEC Electronics data sheets or data books, etc., for the most up-to-date specifications of NEC Electronics products. Not all products and/or types are available in every country. Please check with an NEC Electronics sales representative for availability and additional information.**

- No part of this document may be copied or reproduced in any form or by any means without the prior written consent of NEC Electronics. NEC Electronics assumes no responsibility for any errors that may appear in this document.
- NEC Electronics does not assume any liability for infringement of patents, copyrights or other intellectual property rights of third parties by or arising from the use of NEC Electronics products listed in this document or any other liability arising from the use of such products. No license, express, implied or otherwise, is granted under any patents, copyrights or other intellectual property rights of NEC Electronics or others.
- Descriptions of circuits, software and other related information in this document are provided for illustrative purposes in semiconductor product operation and application examples. The incorporation of these circuits, software and information in the design of a customer's equipment shall be done under the full responsibility of the customer. NEC Electronics assumes no responsibility for any losses incurred by customers or third parties arising from the use of these circuits, software and information.
- While NEC Electronics endeavors to enhance the quality, reliability and safety of NEC Electronics products, customers agree and acknowledge that the possibility of defects thereof cannot be eliminated entirely. To minimize risks of damage to property or injury (including death) to persons arising from defects in NEC Electronics products, customers must incorporate sufficient safety measures in their design, such as redundancy, fire-containment and anti-failure features.
- NEC Electronics products are classified into the following three quality grades: "Standard", "Special" and "Specific".

The "Specific" quality grade applies only to NEC Electronics products developed based on a customer-designated "quality assurance program" for a specific application. The recommended applications of an NEC Electronics product depend on its quality grade, as indicated below. Customers must check the quality grade of each NEC Electronics product before using it in a particular application.

"Standard": Computers, office equipment, communications equipment, test and measurement equipment, audio and visual equipment, home electronic appliances, machine tools, personal electronic equipment and industrial robots.

"Special": Transportation equipment (automobiles, trains, ships, etc.), traffic control systems, anti-disaster systems, anti-crime systems, safety equipment and medical equipment (not specifically designed for life support).

"Specific": Aircraft, aerospace equipment, submersible repeaters, nuclear reactor control systems, life support systems and medical equipment for life support, etc.

The quality grade of NEC Electronics products is "Standard" unless otherwise expressly specified in NEC Electronics data sheets or data books, etc. If customers wish to use NEC Electronics products in applications not intended by NEC Electronics, they must contact an NEC Electronics sales representative in advance to determine NEC Electronics' willingness to support a given application.

(Note)

- (1) "NEC Electronics" as used in this statement means NEC Electronics Corporation and also includes its majority-owned subsidiaries.
- (2) "NEC Electronics products" means any product developed or manufactured by or for NEC Electronics (as defined above).